

6000E

User's Manual

ENGLISH

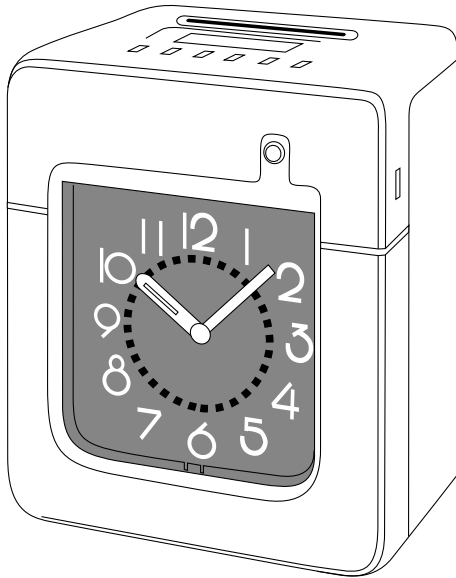

Lathem Time Corporation

WARNING

This equipment has been tested and found to comply with the limits for a Class A digital device, pursuant to Part 15 of FCC Rules. These limits are designed to provide reasonable protection against harmful interference when the equipment is operated in a commercial environment. This equipment generates, uses, and can radiate radio frequency energy and, if not installed and used in accordance with the instruction manual, may cause harmful interference to radio communications. Operation of this equipment in a residential area is likely to cause harmful interference in which case the user will be required to correct the interference at his or her own expense.

Caution: Changes or modifications not expressly approved by the party responsible for compliance could void the user's authority to operate the equipment.

THIS DIGITAL APPARATUS DOES NOT EXCEED THE CLASS A LIMITS FOR RADIO NOISE EMISSIONS FROM DIGITAL APPARATUS AS SET OUT IN THE RADIO INTERFERENCE REGULATIONS OF THE CANADIAN DEPARTMENT OF COMMUNICATIONS.

LE PRÉSENT APPAREIL NUMÉRIQUE N'ÉMET PAS DE BRUITS RADIOÉLECTRIQUES DÉPASSANT LES LIMITES APPLICABLES AUX APPAREILS NUMÉRIQUES DE CLASSE A PRESCRITES DANS LE RÈGLEMENT SUR LE BROUILLAGE RADIOÉLECTRIQUE ÉDICTÉ PAR LE MINISTÈRE DES COMMUNICATIONS DU CANADA.

1. The details of this User's Manual are subject to change even without previous notification.
2. This User's Manual has been prepared with the utmost care to cover all aspects of the time clock's use.
3. Be sure to use your time clock after you have fully understood the hardware and software specifications and limits.
4. No part of this publication may be reproduced, stored in a retrieval system, or transmitted, in any form or by any means, mechanical, photocopying, recording or otherwise.

This User's Manual and its contents are copyrighted by LATHEM TIME CORP. with all rights reserved.



Lathem Time Corporation

www.lathem.com
(800) 241-4990
(404) 691-1065

TABLE OF CONTENTS



1. PRECAUTIONS	1
2. FEATURES	3
3. BEFORE USING THE TIME RECORDER	4
Accessories	4
Location of Controls	4
Installing Ribbon Cassette	5
Mounting Unit on Wall	6
Environmental Conditions	6
4. DAILY OPERATIONS	7
5. SETTING	8
Preparation for setting	8
Setting Pay Ending and Card	9
Setting the Date and the Time, 1/60 or 1/100 printing, the 12/24 HOUR format	13
Setting the Day Advance Time	15
Setting the Daylight Saving Time (D.S.T.)	16
Setting the Time Table Program	19
Setting Number of Seconds for External Time Signal	26
Resetting	27
6. CONNECTING EXTERNAL TIME SIGNAL	28
7. INSERTING Ni-Cd BATTERY	29
8. TROUBLESHOOTING	30
9. SPECIFICATIONS	31
10. TIME CARD SPECIFICATIONS	32





1. PRECAUTIONS







This operation manual is prepared for safe and proper use of the unit. Please follow all the instructions to avoid possible danger to yourself or others and damage to the unit.



Signs

Various warnings and cautions are provided throughout this manual along with signs. Remember each sign and its explanation listed below for your safety and proper operation of the unit.

	Warning	Improper handling may cause bodily accidents including death and serious injury.
	Caution	Improper handling may harm the human body or material.

	Improper handling may cause electric shock DANGER.		Must-Do sign.
	DO NOT disassemble the unit.		Be sure to remove the line cord plug from the outlet.
	Don't sign.		

 Warning	
	Do not disassemble the unit. There is a high voltage present inside, possibly leading to an electric shock.
	Do not modify the unit. Modifications may cause a fire and/or electric shock.
	If any anomaly occurs, for example, heat or smoke is generated or obnoxious odor is emitted, unplug the unit immediately and contact your dealer for servicing. There is a danger that further use may cause a fire or electric shock.
	Do not use any voltage of the power source other than designated. Do not share a single outlet with another plug. These may lead to fire or shock hazards.
	Do not damage, break, or modify the power cord. Do not put a heavy object on, yank, or forcefully bend the cord, either. These may damage the cord, possibly resulting in a fire or electric shock.

-  If foreign matter should get in the unit (including a piece of metal, water, or liquid), disconnect the plug from the outlet immediately and contact your dealer for servicing. There is a danger that further use may cause a fire or electric shock.
-  Do not plug or unplug the unit with a wet hand. You may get an electric shock.

 **Caution**

-  Do not place the unit on an uneven or tilted surface. This may result in injuries due to the unit dropping or falling off.
-  Do not put a water-filled container or a metal object on top of the unit. If water is spilled or the metallic object slips inside, a fire or shock hazard may be caused.
-  Do not install the unit in a humid or dusty environment. It may cause a fire or electric shock.
-  Do not place the unit near kitchen counter or humidifier. Oil, smoke, or steam generating from them may cause fire or shock hazards.
-  Do not yank the power cord to disconnect from the outlet. Hold the plug with your hand to do so, or the cord may be damaged, possibly leading to a fire or electric shock.
-  Remove the line cord plug from the outlet before transferring the unit, or it may damage the cord, possibly leading to a fire or electric shock.
-  Be careful not to contact the print head as you may get hurt or burned .
-  Make sure to insert the power plug as far as it will go. Improper insertion of the plug may develop fire or shock hazards.
-  Do not insert or drop any other time card than specified into the slot. Such misuse may cause a fire or electric shock.
-  If the unit should be dropped or the case be broken, unplug the unit and contact your dealer for servicing. Further use may lead to a fire or shock hazard.
-  Lithium battery contains perchlorate material - special handling may apply. Please go to web site <http://www.dtsc.ca.gov/hazardouswaste/perchlorate> for information about proper methods of disposal.

Daily Care

For cleaning, turn the power off and wipe the case clean of dust and dirt with a dry cloth, etc.

2. FEATURES

- The time table program provides the following functions:
 - Automatic switching between black and red printing
The two-color printing system makes it possible to easily see an employee's in and out time.
 - Automatic activation of an external time signal
The unit can be programmed to externally putout a signal when it's time to start or quit, or for breaks.
 - Automatic switching among six print columns (Columns 1-6)
The auto-switching function of a column to print records in prevents punching failure or error.
- It has selectable three pay periods, weekly, bi-weekly or monthly pay period system.
- Monthly card automatically sense the front or back of the card, therefore assuring no erroneous date printing.
- If the closing date for payroll processing does not fall on the end of a month, the unit can be set to any desired closing date.
- The day advance time function makes it possible to print out on the same line of a time card for the previous working day even when leaving the office after midnight.
- An easy-to-see analog clock is provided on its front for users' convenience.
- User-friendly operation and easy setting enhances users' comfort.

You can usually obtain technical support and order accessories from the store where you bought the clock. To contact Lathem, go on-line to www.lathem.com or call 800-241-4990 (404-691-1065 outside USA).

3. BEFORE USING TIME RECORDER

Accessories

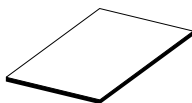

Operation Manual

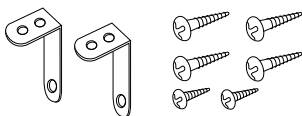

Wall mount fittings

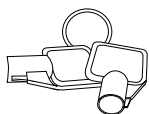

Keys

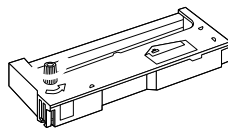

Ribbon cassette

Location of Controls

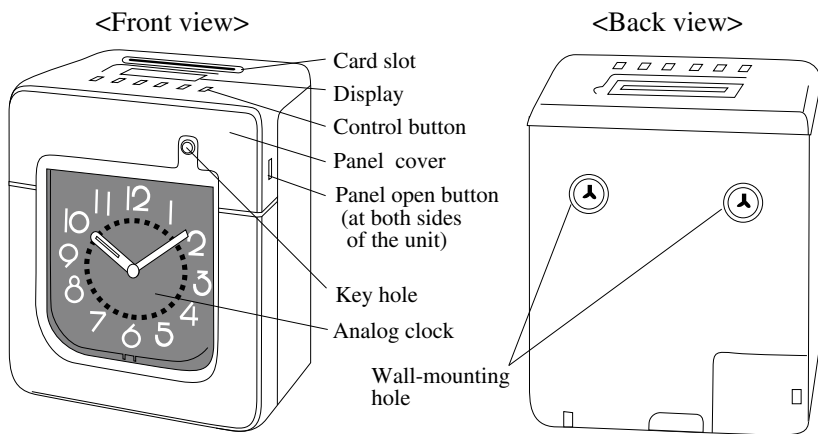

<Display>

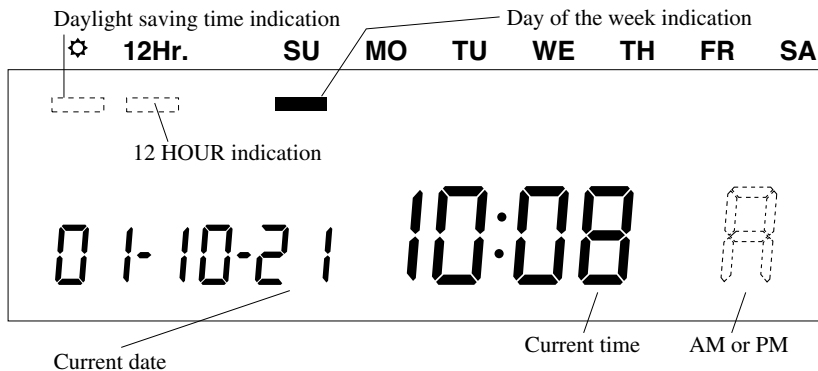

Installing Ribbon Cassette

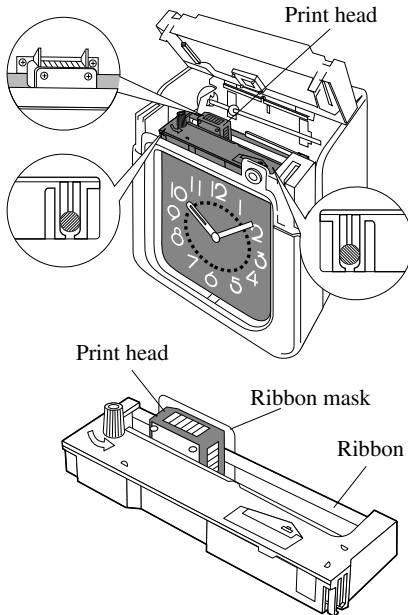
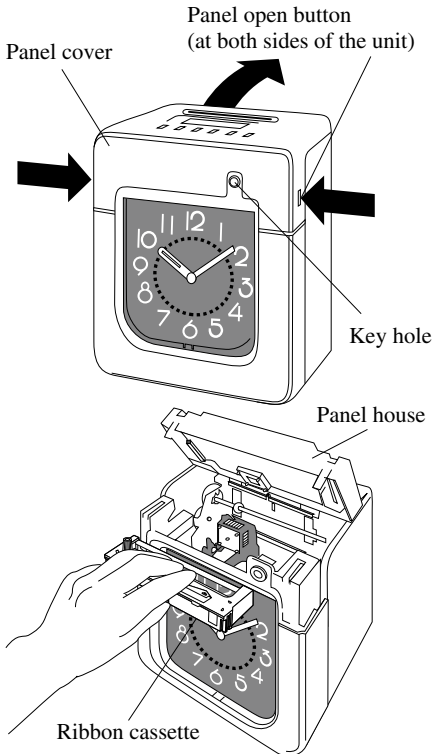

1 Unlock the unit. While holding down the panel open buttons at both sides of the unit, lift the panel cover away from you.

2 Turn the knob on the cassette in the arrow-indicated direction to make the ribbon taut.

To insert the ribbon cassette inside the unit, lift the panel house away from you first. Then thread the ribbon between the ribbon mask and the print head. Slide the latch on the lower side of the cassette into projections on the unit. Then let the cassette snap into place.

When having difficulty inserting the ribbon, insert it while turning the knob.

Make sure that the ribbon is placed between the print head and the ribbon mask as illustrated in the figure at left.

3 Put the panel cover on the hook at the back of the unit. Lower it toward this side to close and lock the unit.

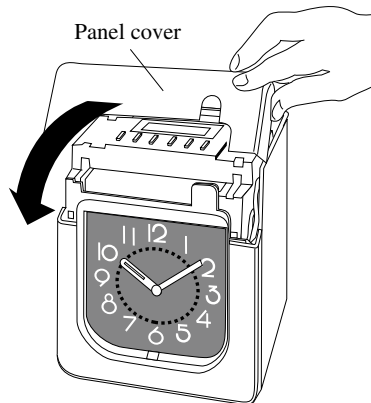

Mounting Unit on Wall

The unit can be mounted on a wall using the supplied mounting fittings. To mount the unit on a wall, take the following steps:

- 1 Install the two larger screws into a wall 10 cm (3.94") apart. Be sure to keep about 3 mm (0.12") of the screw head out of the wall.



The supplied screws are intended for use on a thick wooden wall or wooden column. Do not use them on any other materials. There is a danger that the unit may come off etc.

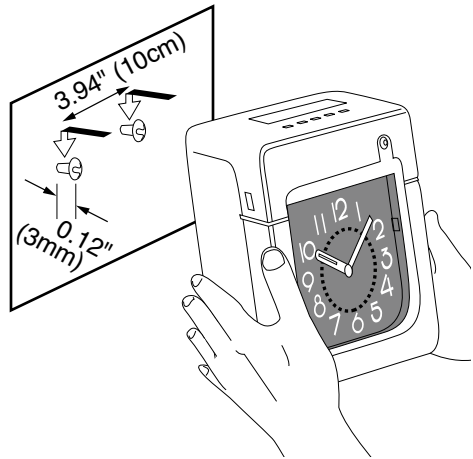

- 2 Mount the wall mount fittings as shown on the right.

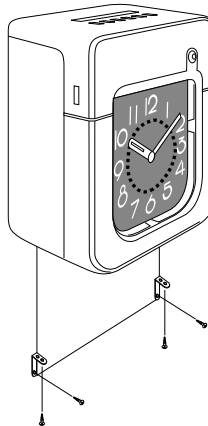

Environmental Conditions

Avoid placing the unit in environments that are:

- humid or dusty
- exposed to direct sunshine
- subject to frequent or continuous vibrations
- outside the temperature range between -5° and 45°C
- affected by chemicals or ozone

4. DAILY OPERATIONS

Once the AC line cord is plugged into the outlet, the unit can be used immediately as basic operation has been pre-set at the factory, including the time and the closing date.



See 3 BEFORE USING TIME RECORDER.

It is easy to operate the unit. Just insert a time card. The card is then automatically pulled in, printed and then ejected.



Do not let any metallic object get into the slot including paper clips. Do not forcefully push in a card, either. These may cause the unit to malfunction.

If any setting needs to be changed, such as for a closing date or other items, See 5 SETTING.

The unit is designed to print in black on the first column when no time table program is set. Usually it is necessary to set the time table program in order to automatically print colors and to change columns to print records in. For a temporary change of a column, however, manual operation is also available: just push the button for any desired column before inserting a time card.

The button for the column selected lights up.

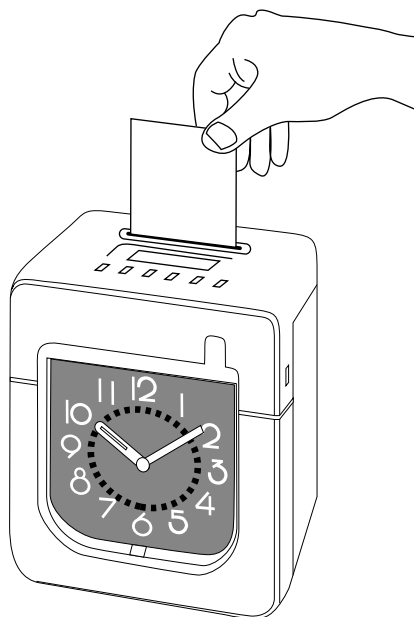

5. SETTING

Preparation for setting

To prepare for setting:

- 1 Unlock the unit. While holding down the panel open buttons at both sides of the unit and lift the panel cover away from you.
- 2 Remove the panel cover.

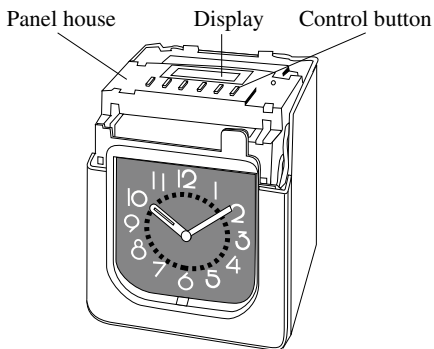
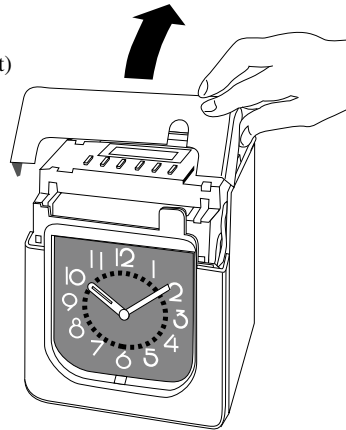
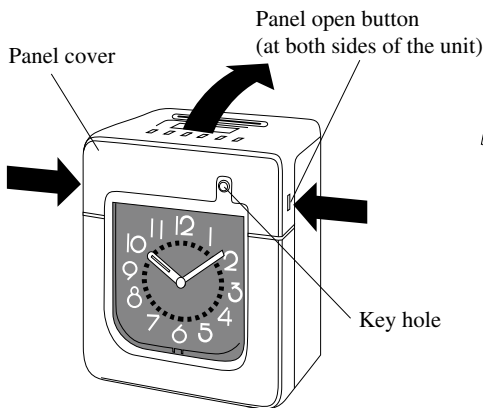

- 3 Make settings using the display and control buttons at the panel house.



Be sure to make settings with the power on.

Upon opening the panel cover, the **PAY ENDING** button lights up and the unit is in the pay ending setting mode.

Make sure to press **SET** at the completion of each setting. Contents are NOT stored in memory if **SET** is not pressed.

Setting Pay Ending and Card / Print Language

- The closing date is factory-set at the end of a month (31st).
- The **PAY ENDING** button stays lit up during its setting operation.

Monthly Closing

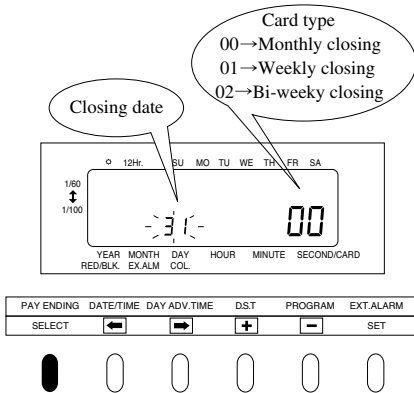

1 Remove the panel cover.
Make sure that the **PAY ENDING** stays lit up.

2 The closing date is shown at the left on the display, and the card type at the right.

The card type for monthly closing is "00".

3 **+** or **-** to select date desired.
Example: If closing date is the 20th every month, set the digits on the left at "20".

Always select the 31st in the case of month-end closing which is normally factory-set unless you change the setting.

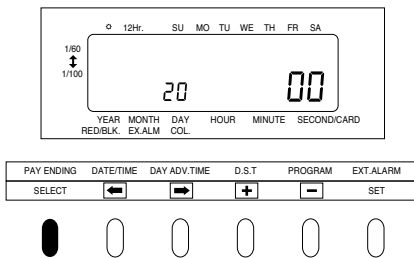

4 Check the settings on the display and press **SET**.

Use monthly cards for monthly closing. The date and time are recorded on the card.

Weekly Closing

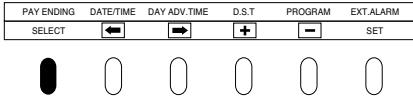
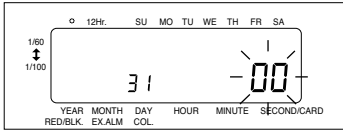

Weekly closing

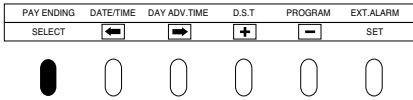
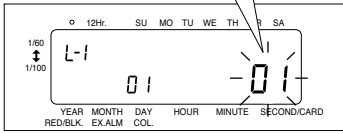

Today is printed on the second line from the top.

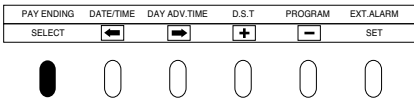
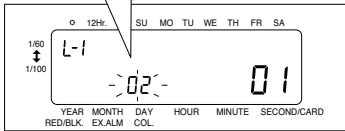

Today
Tuesday, January 8, 2002

Set closing day
Sunday, January 13, 2002

	IN	OUT	IN	OUT	IN	OUT
1						
2						
3						
4						
5						
6						
7						

Print language
(Day of the week)

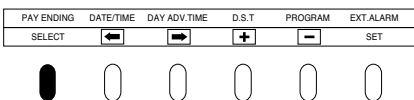
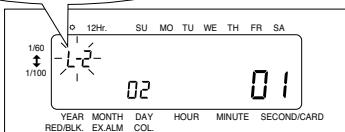

1 Remove the panel cover.
Make sure that the **PAY ENDING** button stays lit up.

2 Press **←** or **→** to cause the digits at the right to flash ("00").

3 Press **+** or **-** to select "01".

4 Press **←** or **→** to cause the digits at the center to flash.

Today's printing line can be set at any line from above on the weekly card, by referring to the example below.

Example: Assume that today is Tuesday, 8 January 2002 and the closing date is Sunday.

As illustrated in the figure on the left, today's printing line is set at the second line from the top since Sunday becomes the closing date if Sunday, 13 January 2002 is set at the bottom line.

Press **+** to set the number of the display at "02".

5 Press **←** or **→** to cause the digits at the left to flash "L-1".

6 Press **+** or **-** to select "L-2", if you want to set "Spanish".

Order Options			
L-1	English	L-4	French
L-2	Spanish	L-5	Italian
L-3	German	L-6	Portuguese

7 Check the settings on the display and press **SET**.

Use Weekly Cards for weekly closing.
The day of the week and time are recorded on the card.

Bi-Weekly Closing

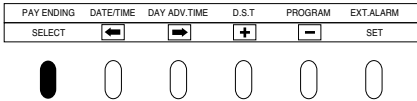
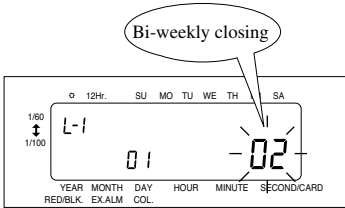
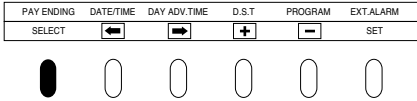
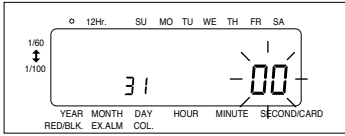

Today is printed on the ninth line from the top.

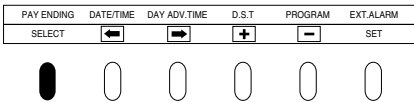
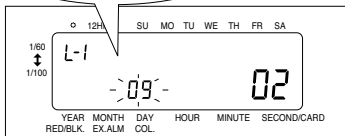

Today
Tuesday, January
8, 2002

Set closing day
Sunday, January
13, 2002

	IN	OUT	IN	OUT	IN	OUT
1						
2						
3						
4						
5						
6						
7						
8						
9						
10						
11						
12						
13						
14						

1 Remove the panel cover.
Make sure that the **PAY ENDING** stays lit up.

2 Press **←** or **→** to cause the digits at the right to flash "00".

3 Press **+** or **-** to select "02".

4 Press **←** or **→** to cause the digits at the left to flash.

Today's printing line can be set at any line from above on the bi-weekly card by referring to the example below.

Example: Assume that today is Tuesday, 8 January 2002 and the closing date is this Sunday, 13 January 2002. Therefore, today corresponds to the second Tuesday of this pay period. As illustrated in the left figure, today's printing line is set at the ninth line from the top if Sunday, 13 January 2002 is set at the bottom line.

Press **+** or **-** to set the number of the display at "09".

Print language
(Day of the week)

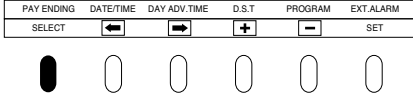
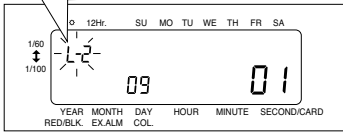

5 Press **←** or **→** to cause the digits at the left to flash "L-1".

6 Press **+** or **-** to select "L-2", if you want to set "Spanish".

Order Options			
L-1	English	L-4	French
L-2	Spanish	L-5	Italian
L-3	German	L-6	Portuguese

7 Check the settings on the display and press **SET**.

Use Bi-Weekly Cards for bi-weekly closing. The day of the week and time are recorded on the card.

Setting the Date and the Time, 1/60 or 1/100 printing, the 12/24 HOUR format

The **DATE/TIME** button stays lit up during its setting operation.

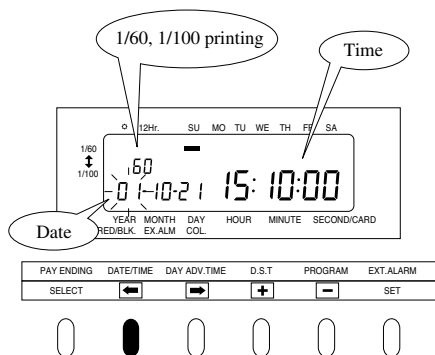

1 Press **SELECT** to illuminate the second button from the left, **DATE/TIME**.

Date is indicated at the left, and time at the right on the display.

To set the number, the digits must flash.

2 To set date

Press **←** or **→** to cause digits to flash and press **+** or **-** to select the desired date.

Example: For October 21, 2001, adjust the digits to "01-10-21".

3 To set time

Press **←** or **→** to cause the digits to flash and press **+** or **-** to select the desired time.

When the hour and minute are entered, the second indication is automatically reset at "00".

How to set 12 hour format

When you want to apply 12 hour format both on LCD time and printing format on the time card, select 12 hour format first as described below.

Press **←** or **→** to cause the bar under "12 Hr." to flash and press **+** or **-** to select 12 hour format. Check the settings on the display and press **SET**.

Thereafter press **←** or **→** to cause the digits indicating hour to flash, then follow step 3, above.

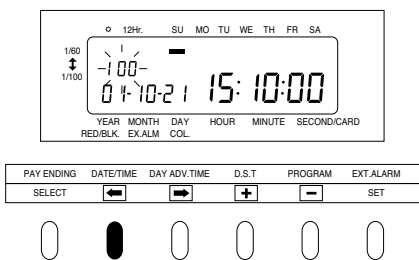

Example of printing:
 In the case of 14:58
 1/60 indication → 14:58
 1/100 indication → 14.98

4 Setting for 1/60 or 1/100 printing
 Press or to cause the digits at the upper left to flash.
 Press or to select the printing between 1/60 or 1/100.

5 Check the settings on the display and press **SET**.

Setting the Day Advance Time

The day advance time refers to the time when printing shifts to the next line on a time card for the next day. This function, if printed before the set day advance time, enables the time record to print on the same line of the previous working day even if leaving time is after midnight.

- The day advance time is factory-set at 5:00 a.m. (05:00).
- The **DAY ADV. TIME** button stays lit up during its setting operation.

1 Press **SELECT** to cause the third button from the left, **DAY ADV. TIME** to light up.

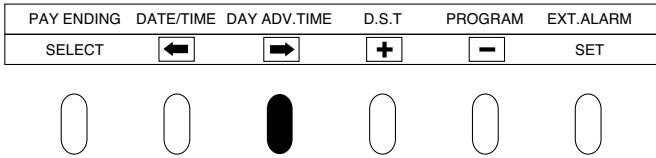
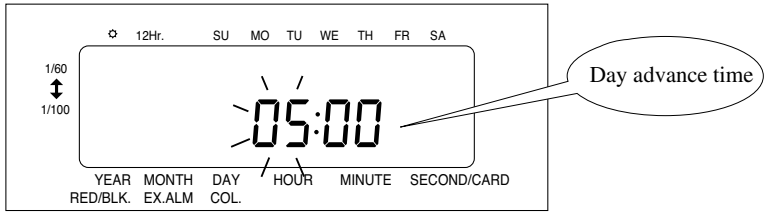

2 Press **←** or **→** to cause digits to flash, and then press **+** or **-** to select the desired time.

Example: If the day advance time is 7:30 a.m., adjust the digits to "07:30".

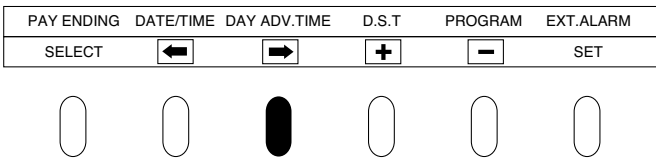
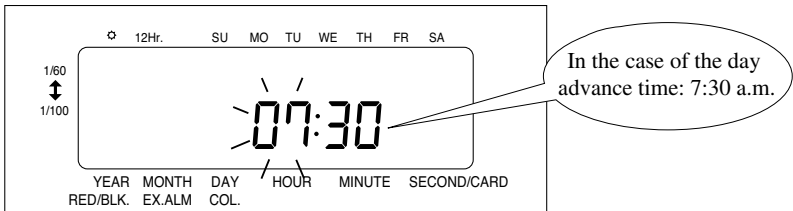

3 Check the settings on the display and press **SET**. Now the setting is completed.

Setting the Daylight Saving Time (D.S.T.)

Daylight saving time function

1 D.S.T. execution time

At 2:00 a.m. on the first day of summer time, the clock automatically gains one hour to show 3:00 a.m. When 3:00 a.m. comes on the last day of the summer time period, it loses one hour and returns to 2:00 a.m.

2 Setting D.S.T.

Example:

Start date Sunday, March 25, 2001

End date Sunday, October 28, 2001

If set as the above, the unit remembers the start date as the last Sunday of March and the end date as the last Sunday of October. Once set, the unit automatically updates the settings every year thereafter. No further manual setting is necessary.

- Daylight saving time is not pre-set at the factory (with the indication of month 00 and day 00).
- The **D.S.T.** button stays lit up during its setting operation.

1 Press **SELECT** to cause the fourth button from the left, **D.S.T.** to light up.

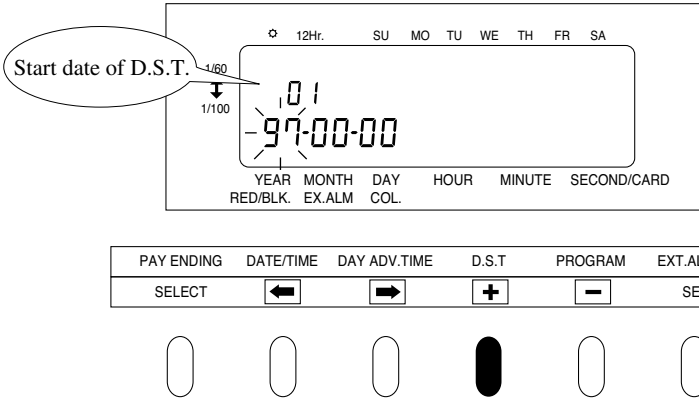

2 Setting the start date

"01" is indicated at the upper left of the display during setting of the start date.

(1) Press **←** or **→** to cause digits to flash, and then press **+** or **-** to select the desired time.

Example: If your D.S.T. starts on March 25, 2001, adjust the digits to "01-03-25".

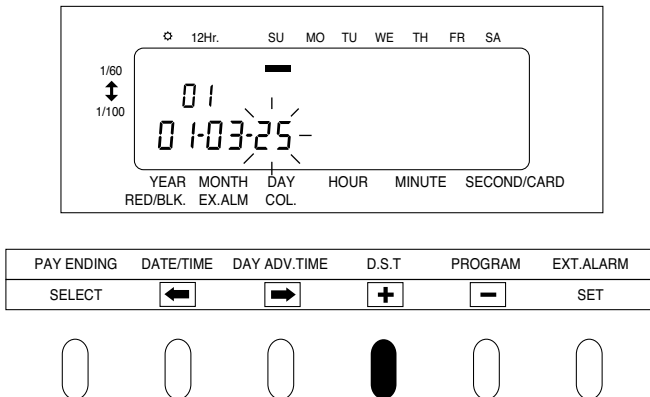

(2) Check the settings on the display and press **SET**. Now the setting is completed.

3 Setting the end date

When the start date setting is completed, the indication at the upper left automatically shifts to "02". You are now in the end date setting mode.

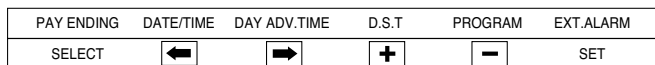
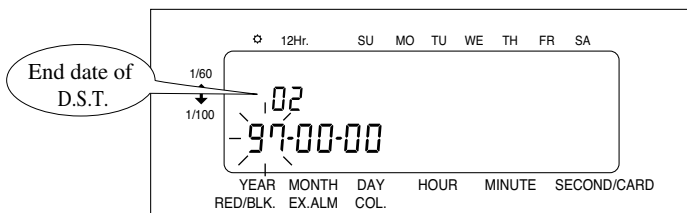

(1) Press **←** or **→** to cause digits to flash, and then press **+** or **-** to select the desired time.

Example: If D.S.T ends on October 28, 2001, adjust the digits to "01-10-28".

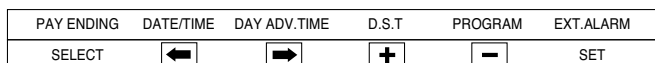
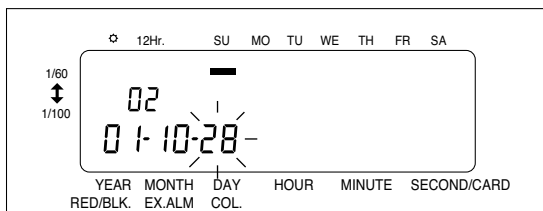

(2) Check the settings on the display and press **SET**. Now the setting is completed.

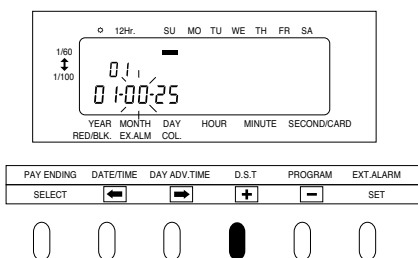

How to Cancel D.S.T. Settings

Place the unit to the D.S.T. start date setting mode as described above (1) and press **←** or **→** to cause month digits to flash. Then select "00" and press **SET** to disable the D.S.T. function.

Setting the Time Table Program

The time table program function allows automatic selection of print color (black or red), an external time signal, and automatic selection of a column to print records in. These functions can be set by the day of the week and time period.

- No time table program is factory-set. (The default is: print in black; no external time signal; and print in Column 1.)
- The **PROGRAM** button stays lit up during its setting operation.

The time table program is explained using the following example.

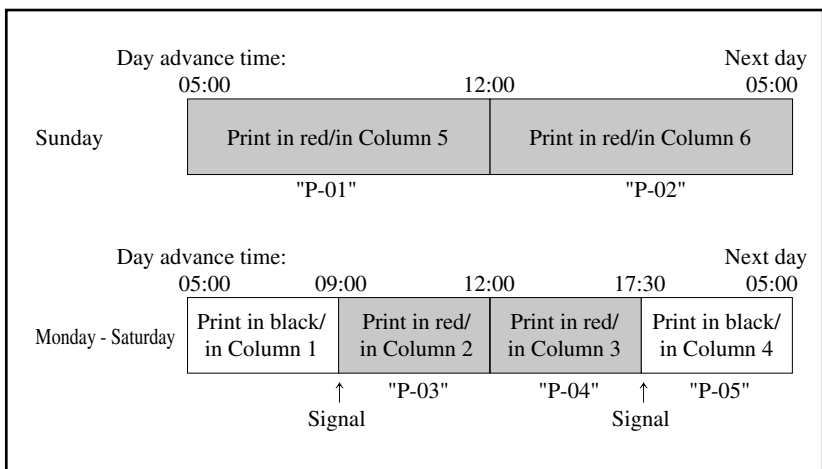

The following is the time table based on the case above.

Program No.	Day of week	Time	Print color	External time signal	Print column
P-01	Sun.	05:00	Red		5
P-02	Sun.	12:00	Red		6
P-03	Mon. - Sat.	09:00	Red	✓	2
P-04	Mon. - Sat.	12:00	Red		3
P-05	Mon. - Sat.	17:30	Black	✓	4

- Times are always printed in black in Column 1 for the time period with no program setting.
- One programmed day begins at the day advance time. See "Setting Day Advance Time" in this section for details.
- Up to 32 programs can be set (P-01 through P-32).

Follow the steps to set time table programs.

1 Press **SELECT** to cause the **PROGRAM** button light up.

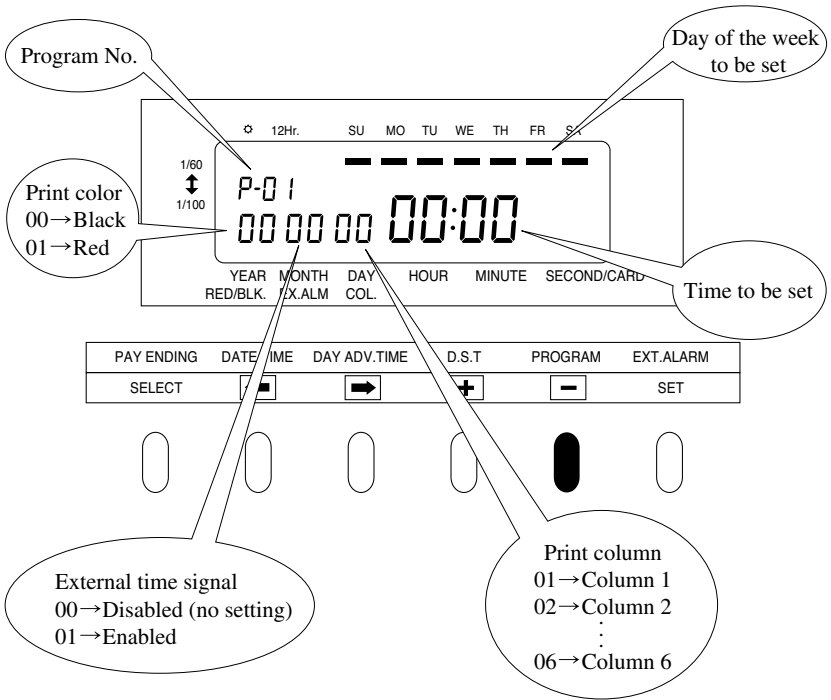

P-01

Print in red

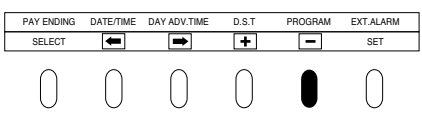
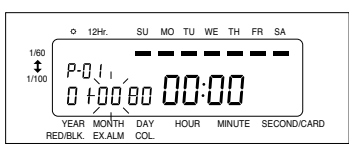
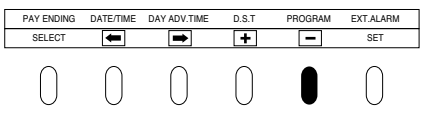
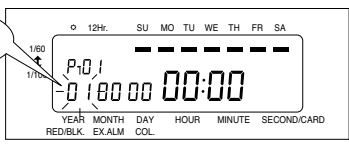

Print in column 5

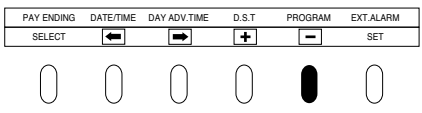
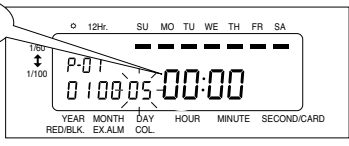

05:00

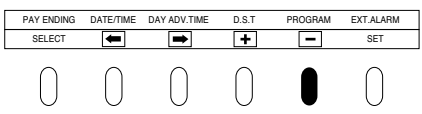
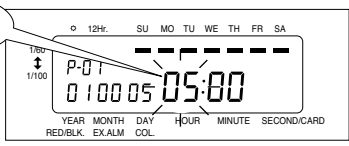

2 To set P-01 (shown in the table above)

(1) Print color

With "P-01" flashing, press **→** once. The print color indication flashes at the lower left of the display. "00" represents "print in black." Press **+** and change the digits to "01" to be set at "print in red."

(2) External time signal

Press **→** once. The external time signal indication flashes. "00" represents "disabled (no setting)". Leave the digits as they are since no setting is necessary for the P-01 program.

To enable an external time signal, select "01".

(3) Print column

Press **→** once. The print column indication flashes. "01" represents "Column 1". Press **+** and change the digits to "05" to set "print in Column 5".

(4) Time

Press **→** the hour indication flashes. Press **+** to change the digits to "05" to set "05:00".

00 minute

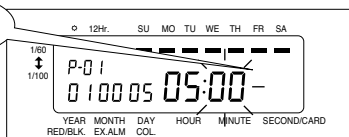

PAY ENDING	DATE/TIME	DAY ADV.TIME	D.S.T	PROGRAM	EXT.ALARM
SELECT	←	→	+	-	SET

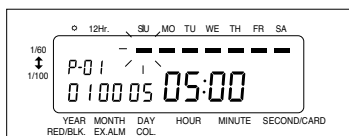

PAY ENDING	DATE/TIME	DAY ADV.TIME	D.S.T	PROGRAM	EXT.ALARM
SELECT	←	→	+	-	SET



Erase "-"
under MO.

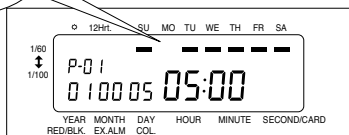

PAY ENDING	DATE/TIME	DAY ADV.TIME	D.S.T	PROGRAM	EXT.ALARM
SELECT	←	→	+	-	SET



Erase "-"
under TU.

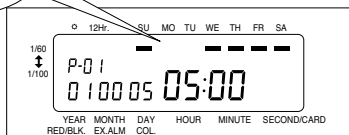

PAY ENDING	DATE/TIME	DAY ADV.TIME	D.S.T	PROGRAM	EXT.ALARM
SELECT	←	→	+	-	SET



Press again. The minute indication flashes.

Leave the digits as they are since the desired time is 05:00 in this case.

(5)Day of the week

Press . The bar under "SU" flashes ("-").

The factory setting for a day of the week is all days from Sunday through Saturday. If only Sunday needs to be selected, the bars under Monday through Saturday have to be cancelled.

For the P-01 program, to select Sunday only.

First, press to cause the bar under "MO" to flash, and press once to erase the bar ("-").

At that time, the bar under "TU" is already flashing automatically.

Press again to erase the bar ("-").

Erase "-"
under MO - SA.

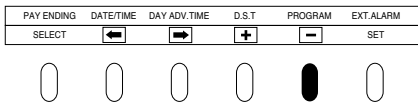
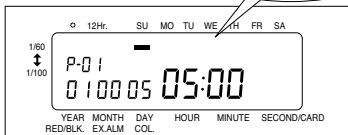

Take the same steps described above to erase the bars for the remaining days of the week.

After erasing the bar under "SA", press **SET**.

The P-01 indication stays lit up completing the P-01 program setting.

Staying lit up

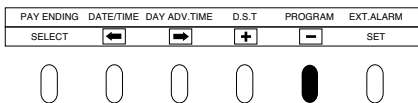
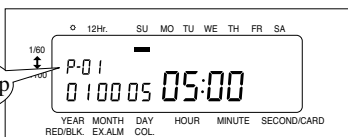

Make sure the bar under any day of the week stays lit up. If none of the bar stays lit up, the time table program will not operate properly.

P-02

Flashing

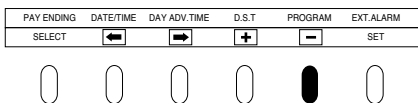
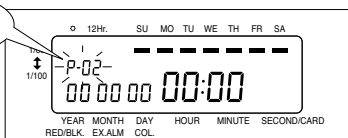

3 To set P-02

After the setting of P-01 is completed, press **+**. The program NO., the indication at the upper left "P-01" flashes. Then press **+** to enter "P-02" setting mode.

The program NO., indication "P-02" flashes.

Staying lit up

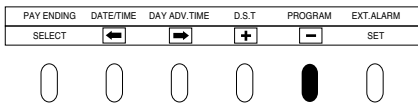
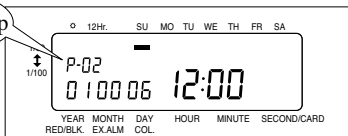

Make settings for P-02 in the same manner as for P-01, as illustrated in the figures at the left.

Press **SET**.

The P-02 indication now stays lit up, showing completion of the P-02 program setting.

Likewise, to shift to P-03, press **+** to cause the P-03 indication to appear flashing.

P-03

Make the bars under MO-SA lit up.

External time signal

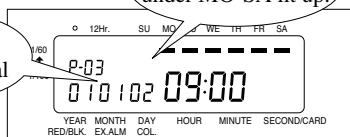

PAY ENDING	DATE/TIME	DAY ADV.TIME	D.S.T	PROGRAM	EXT.ALARM
SELECT	←	→	+	-	SET
○	○	○	○	●	○

P-04



PAY ENDING	DATE/TIME	DAY ADV.TIME	D.S.T	PROGRAM	EXT.ALARM
SELECT	←	→	+	-	SET
○	○	○	○	●	○

P-05

Print in black

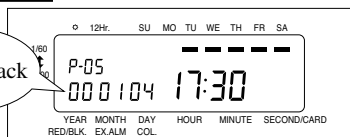

PAY ENDING	DATE/TIME	DAY ADV.TIME	D.S.T	PROGRAM	EXT.ALARM
SELECT	←	→	+	-	SET
○	○	○	○	●	○

4 To set P-03

Make settings as shown in the figure at left, and press **SET**.

5 To set P-04

Make settings as shown in the figure at left, and press **SET**.

6 To set P-05

Make settings as shown in the figure at left, and press **SET**.

Now the setting of the programs in the table are all complete.

To check program settings

Press **SELECT** to cause **PROGRAM** to light up. Make the desired program No. flash. To see program settings, press **+**.

The **+** button switches among programs in order starting from P-01. Program contents are shown on the display in order starting from Sunday and the line feed time.

To modify program settings

Press **SELECT** to cause **PROGRAM** to light up. Make the desired program No. flash.

Press **←**, **→**, **+**, or **-** to change the settings in the same manner as in its initial setting.

To erase program settings

Press **SELECT** to cause **PROGRAM** to light up. Make the desired program No. flash. The **+** button switches among programs in order starting from P-01. Select the desired program No.

To erase it, set the print column indication at "00" and press **SET**.

Example:

To erase P-04, set the print column indication at "00" and press SET as shown in the figure at left.

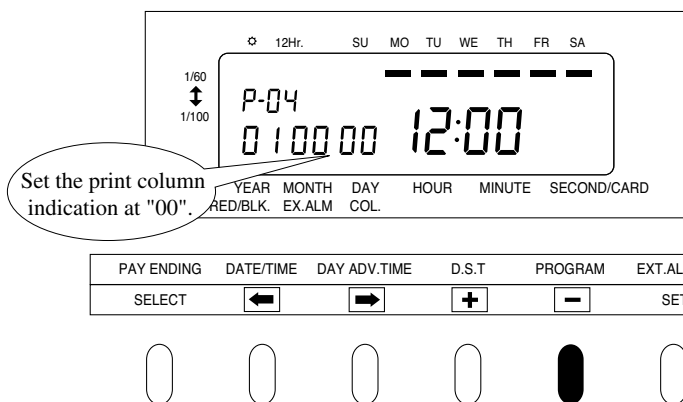

Follow the same procedure described above to make settings for the desired program.

Setting Number of Seconds for External Time Signal

This function is to set the duration of External time signal. The setting is enabled only when External time signal is set in the time table program.

- The duration is factory-set at 5 seconds.
- The **EXT. ALARM** button stays lit up during its setting operation.

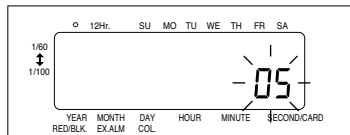

PAY ENDING	DATE/TIME	DAY ADV.TIME	D.S.T	PROGRAM	EXT.ALARM
SELECT	←	→	+	-	SET



1 Press **SELECT** to cause **EXT. ALARM** to light up.

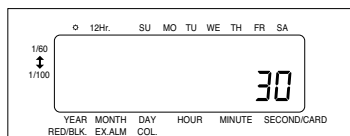

PAY ENDING	DATE/TIME	DAY ADV.TIME	D.S.T	PROGRAM	EXT.ALARM
SELECT	←	→	+	-	SET



2 Press **+** or **-** to adjust the duration in seconds.

Example: To set for 30 seconds, set the second indication at "30".

For the number of seconds, 1 through 30 can be selected

3 Check the settings on the display and press **SET**.

Resetting

To restore all the settings to factory-shipped state, push the reset switch with a pointed object.

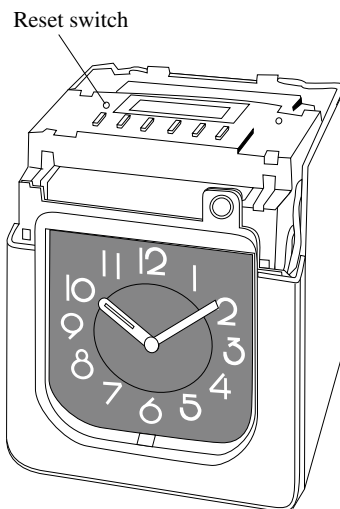

Be careful! Resetting will erase all the settings made by users.
For setting, see 5 Setting.

6. CONNECTING EXTERNAL TIME SIGNAL

Follow the steps below to connect an external time signal device.

Bottom View

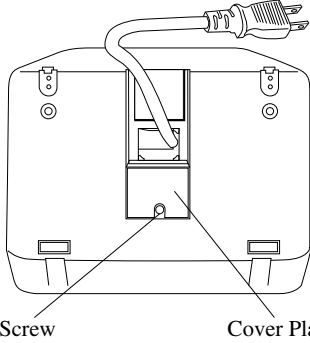

1 Unscrew the screw fixed on the bottom of the unit to remove the cover plate.

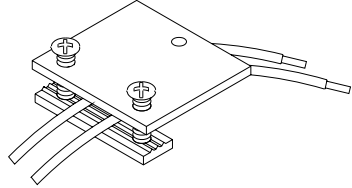

2 Feed wires through clamp. Do not tighten clamp screws.

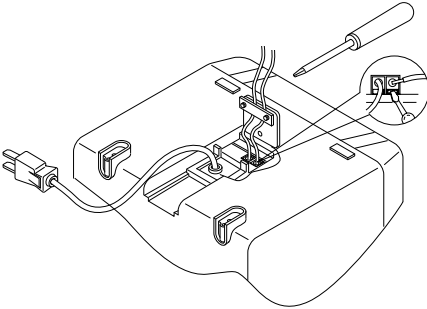

3 Insert wires into Terminals while pushing upper part of Terminal Block with screwdriver, then tighten both screws of cable clamp.

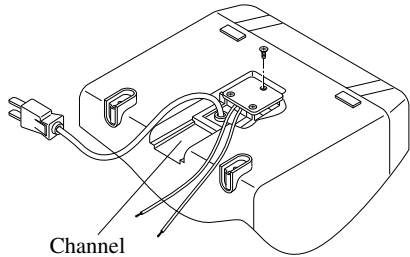

4 Fold down Cover Plate and secure with screw. Route Power and Bell wires through Channel in base of clock.

Connection Specifications for External Contact

- Contact output: One circuit, dry contact
- Contact capacity: 5A, 30VDC 2A, 120VAC

Maximum of 8 bells/horns (typical)

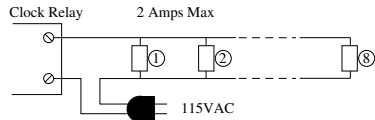

7. INSTALLING Ni-Cd BATTERY (optional)

Follow the steps below to install a Ni-Cd battery (optional) in case of power failure.

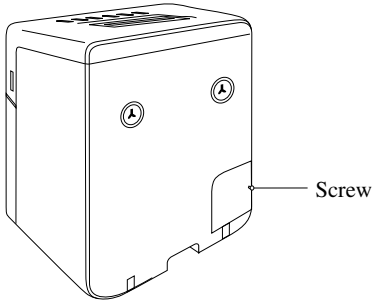

- 1** Unscrew the screw that holds the lid of the battery compartment in the lower right-hand corner of the back of the unit.

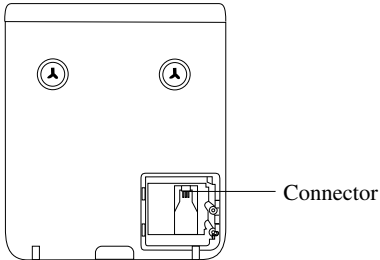

- 2** Insert the battery connector into the compartment connector to install the battery.

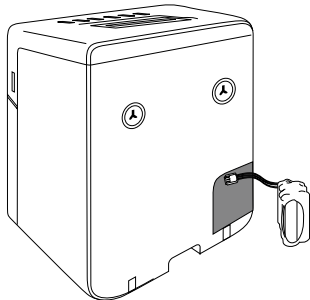

- 3** Hook the lid to close, and secure it with the screw.

Use only the originally offered Ni-Cd Battery.

8. TROUBLESHOOTING

Error No. appears

Refer to the following list for proper operation.

No.	Error contents	Action
E-03	The card is inserted wrong side up.	Insert the card with its right side up.
E-05	The card is not pulled in properly.	Insert the card again.
E-30	Does not print. There is an anomaly in the printer motor or home position sensor.	Open the panel cover to ensure that: <ul style="list-style-type: none">• there is no jammed card, and• the ribbon cassette is set in place.
E-33	Color switching does not work in printing.	Close the cover after checking. If an error No. still appears, contact your dealer for servicing.
E-37	The card is not pulled in properly. The card forwarding motor or sensor does not operate properly.	
E-38	Printing cannot be performed. The print head motor or sensor does not operate properly.	

Other failures

● The unit does not operate.

Check whether the power cord is properly plugged into an AC outlet.

● The unit does not print.

Check whether the ribbon is installed in place.

● Print is not produced in the right place.

Check whether the settings of the closing date is set correctly.

Check whether the day advance time is set correctly.

Make sure that no part of the time card is folded, and that the time card is inserted straight into the unit.

9. SPECIFICATIONS

Clock accuracy	Monthly accuracy $\pm 15s$ (at ordinary temperature)
Calendar	Year up to 2096. Automatically adjusted to leap years, 31-day months and months with thirty or fewer days, and the days of the week.
Printing system	Dot matrix in black and red
Card mechanism	Automatic pull and eject, automatic judgment of face and back
Power failure compensation	Five years of cumulative power failure hours after the date of shipment
Print at power failure	Special Ni-Cd battery, 100-time printing or 24 hours (option)
Time program	Switching between black and red printing, designation of the time for outputting an external time signal, automatic column shift.
Connection of external time signal	Connection with a time blow device (No direct voltage output!)
Operating environment	Temperature: -5° to $+45^{\circ}C$: $+23^{\circ}$ to $+113^{\circ}F$ Humidity: 20 to 80%RH, no condensation The unit operates normally at temperatures of $5^{\circ}C$ or below, but the print density, reaction of the liquid crystal display, and the number of prints at power failure are inferior to those at normal temperature operation.
Dimensions	7.87" (w) x 10.1" (h) x 5.94" (d) 200 (w) x 257 (h) x 151 (d) mm
Weight	Approx. 5.5lbs 2.5kg
Power supply	120VAC 230VAC (220-240VAC)
Power consumption	120VAC 50/60Hz 0.2A 230VAC 50/60Hz 0.12A 220-240VAC 50/60Hz 0.12A

Machine Noise Information Ordinance 3. GSGV, January 18, 1991:

The sound pressure level at the operator position is equal to or less than 70 dB (A) according to ISO 7779.

Maschinenlärminformationsverordnung 3. GSGV, 18.01.1991:

Der arbeitsplatzbezogene Schalldruckpegel beträgt 70 dB (A) oder weniger gemäß ISO 7779.

MANUFACTURER'S WARRANTY

Limited One-Year Warranty

Lathem warrants the model 6000E hardware product against defects in material and workmanship for a period of one year from date of original purchase. The conditions of this warranty and the extent of the responsibility of Lathem Time Corporation ("Lathem") under this warranty are listed below.

1. This warranty will become void when service performed by anyone other than an approved Lathem warranty service dealer results in damage to the product.
2. This warranty does not apply to any product which has been subject to abuse, neglect, or accident, or which has had the serial number altered or removed, or which has been connected, installed, adjusted, or repaired other than in accordance with instructions furnished by Lathem.
3. This warranty does not cover dealer labor cost for removing and reinstalling the machine for repair, or any expendable parts that are readily replaced due to normal use.
4. The sole responsibility of Lathem under this warranty shall be limited to repair of this product, or replacement thereof, at the sole discretion of Lathem.
5. If it becomes necessary to send the product or any defective part to Lathem or any authorized service dealer, the product must be shipped in its original carton or equivalent, fully insured with shipping charges prepaid.
Lathem will not assume any responsibility for any loss or damage incurred in shipping.
6. **WARRANTY DISCLAIMER: Limitation of Liability.** Except in only the limited express warranty set forth above, there are no expressed or implied warranties of merchantability and fitness for a particular purpose. In no event will Lathem be liable for any direct, special, or consequential damages arising out of or in connection with the delivery, use or inability to use, or performance of this product.
7. Proof of date of purchase is required for warranty service on this product.
8. This Warranty grants specific legal rights. Additional legal rights, which may vary by locale, may also apply.
9. Should any difficulties arise with the performance of this product during warranty, or with any Lathem authorized service centers, contact Lathem Time at the address below.

Lathem Time Corporation

200 Selig Drive, SW, Atlanta, Georgia 30336

800-241-4990

www.lathem.com